



PACIFIC CREST
CORPORATION

PDL/ADL/SDL

User's Guide

Revision 3.1
June 2001

PN: M0052203

Shenzhen Sinosun Technology Co.,Ltd.
3A17 South Plaza, Cangsong Building,
Tairan Industry & Trade zone, Futian district, Shenzhen, China
Phone (0086) 755-83849417
Fax (0086) 755-83849434
E-mail:sales2@sinosun.cn
Web:www.sinosun.cn



This page intentionally left blank.

NOTICE

PACIFIC CREST CORPORATION MAKES NO WARRANTY OF ANY KIND WITH REGARD TO THIS MATERIAL, INCLUDING, BUT NOT LIMITED TO, THE IMPLIED WARRANTIES OF MERCHANTABILITY AND FITNESS FOR A PARTICULAR PURPOSE. Pacific Crest Corporation shall not be liable for errors contained herein or for incidental consequential damages in connection with the furnishing, performance, or use of this material.

This document contains proprietary information that is protected by copyright. All rights are reserved. No part of this document may be photocopied, reproduced, or translated into another language without the prior written consent of Pacific Crest Corporation.

The information contained in this document is subject to change without notice.

CAUTIONS AND WARNINGS

 Throughout this manual this symbol is used to indicate caution or warning. Please pay particular attention to these items to assure safe and reliable operation of your radio modem product.

© Copyright 2001 [Shenzhen Sinosun Inc](#) . All rights reserved. Reproduction, adaptation, or translation of this manual is prohibited without prior written permission of [Shenzhen Sinosunc.Inc](#) except as allowed under the copyright laws.

Trimtalk and Trimble are trademarks of Trimble Navigation Ltd.

TABLE OF CONTENTS

Notice	iii
Cautions and Warnings	iii
Table of Contents	iv-v
Introduction	1
Welcome	1
Scope	1
Note Concerning this Guide	1
Features and Benefits	3
Setting Up The PDL/ADL/SDL High Power Base	5
Overview of PDL/ADL/SDL High Power Base Radio Modem	5
PDL/ADL/SDL High Power Base System Setup	6
Setting Up The PDL Low Power Base/Repeater	10
Overview of PDL Low Power Base Radio Modem	10
PDL Low Power Base Setup	11
Setting Up The PDL Rover	12
Overview of PDL Rover Radio Modem	12
PDL Rover Setup	13
Tips and Techniques for Best Performance	14
Antenna	14
Power Supplies	14
How to Use AutoRover™	14
How to Use AutoBase™	14
Equipment Care	15
Error Codes	15
FCC Rules and Regulations	16
Licensing Requirements	16
Equipment Compliances	16
Being Part of the RF community	16
Automatic Station Identification	16
Carrier Sense Multiple Access (CSMA)	17
Service and Support	18
Contacting Pacific Crest Corporation	18
Warranty	20
Two-year Limited Warranty	20
Exclusions	20
Warranty Limitations	20
Appendix A - Safety Information	22
Exposure to Radio Frequency Energy	22
Appendix B - Pin-outs and Connectors	23
PDL Base	23
PDL Rover	23
Antenna	23

TABLE OF CONTENTS (cont.)

Appendix C - Technical Specifications	24
General	24
Radio	24
Modem	24
Environmental	25

Table of Figures

Figure 1 - PDL High Power Base Front Panel	5
Figure 2 - PDL High Power Base Rear Panel	6
Figure 3 - PDL High Power Base System Setup	7
Figure 4 - PDL Low Power Base	10
Figure 5 - PDL Low Power Base Setup.....	11
Figure 6 - PDL Rover	12
Figure 7 - PDL Rover Setup	13
Figure 8 - PDL Data/Power Connectors.....	23

INTRODUCTION

Welcome

Thank you for purchasing the Positioning Data Link™ (PDL™) for use with your survey system. The PDL is an advanced, high speed, wireless data link that is designed specifically for GPS/RTK applications. Your success in using the PDL is our primary goal. We stand behind our product with expert support and service. We welcome your comments and questions.

Scope

This guide introduces the PDL Base and rover radio link systems used for GPS and RTK applications. It is written for the first-time user, and gives details concerning system setup, operation and maintenance. We urge you to take the time to review this short manual completely prior to setting up your system.

Note Concerning this Guide

We believe that the PDL system provides the best value and performance for the user. As such, we provide our equipment in complete turnkey systems, including all of the items necessary for operation with your GPS.

You may have purchased your PDL from a third party. On occasion, the bundled product provided by these sources may differ from the kits provided directly from Pacific Crest Corporation. If this guide does not accurately reflect the equipment that you received, please contact your supplier for specific instructions concerning the setup of items that differ.

This page intentionally left blank.

FEATURES AND BENEFITS

Fast Over-the-Air Data Rate - 19,200 bits per second

- Reduced latency provides better GPS position information
- Lower power consumption allows longer field operation
- Greater throughput handles both GPS and GLONASS

Enhanced User Interface - Channel display and buttons

- View and change radio channel
- Monitor charge status and other parameters

Intelligent Protocols - Forward Error Correction (FEC), AutoBase™ and AutoRover™ technology¹

- FEC provides improved noise immunity and range
- Base automatically selects channel with AutoBase
- Rover automatically locks to base with AutoRover

Rugged Construction - Designed specifically for GPS RTK field surveying

- Double shock mounted electronics improve reliability
- Water tight operation stands up to bad weather conditions
- Built-in mounts simplify tripod and range pole mounting

Backward Compatible - Interoperable with RDDR, RFM and Trimble® products

- Benefit by the latest technology with your existing equipment
- Facilitates GPS equipment mix and match
- Provides upgrade path for existing installations

This page intentionally left blank.

SETTING UP THE PDL HIGH POWER BASE

Overview of PDL High Power Base (PDL HPB) Radio Modem

Front Panel

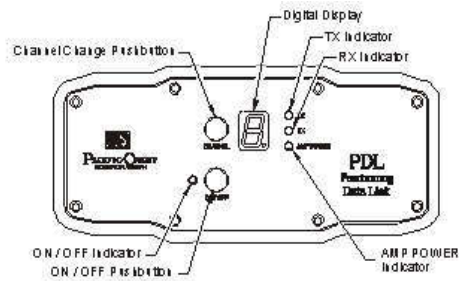

PDL



ADL



SDL

Figure 1 - PDL High Power Base Front Panel

Buttons

The ON/OFF button is used to turn the PDL HPB station on and off. Turn the unit on by pressing the ON/OFF button and holding it until the channel display indicator is lit. Turn off the PDL HPB by pressing the ON/OFF button until the display goes blank. There is a one-second turn-off delay in the power button to prevent inadvertent turn off.

The CHANNEL button is used to display and change the channel. Press the CHANNEL button momentarily to display the selected channel. To change the channel, press the CHANNEL button once to light the display, and then again to change the channel.

Use the CHANNEL button to select the "b" setting. With "b" selected, the PDL HPB will be placed in AutoBase mode. This mode selects the channel for transmission automatically.

Display

The seven-segment numeric display is used to indicate the channel or mode selection. To conserve power, the display is only lit for a short time following the pressing of the CHANNEL or ON/OFF buttons. Channel selections range from Channel 0 to Channel 15. Two digit channel numbers are displayed by alternately flashing a 1 followed by the second digit.

The seven-segment display also has a decimal point to the lower right of the number. The decimal point is lit to indicate that the channel selection was done automatically with AutoRover or AutoBase.

Indicator LEDs

The power LED has two purposes - first, to indicate that the unit is powered, and second, to indicate the level of charge for the power supply. The power LED will blink to indicate that the base station battery is at or below 10 Volts and may require charging.

The amplifier power LED indicates the RF power output level selected. When lit, the amplifier power LED indicates that the RF output power is set to high. When blank, the amplifier power LED indicates that the RF output power is set to low.

The TX LED indicates that the PDL HPB is actively transmitting. In most RTK applications, the base station TX LED will blink once per second.

The RX LED indicates that the PDL HPB is receiving an RF carrier signal. If the RX LED is lit for extended periods of time, or continuously, then another radio station is operating on the same frequency. This competing RF source may interfere with the GPS RTK system, and may require that you change channels for better performance.

Rear Panel

Data Connector

A five-pin circular LEMO style receptacle accepts both programming and GPS model specific cables. The supplied cables are labeled "RADIO" on the end that plugs into the base. Align the red dot on the plug with the red dot on the receptacle and push until a clicking sound is heard.

To remove the cable, grasp the blue cable over-mold, and retract the locking mechanism by pulling the knurled barrel of the plug toward your palm.

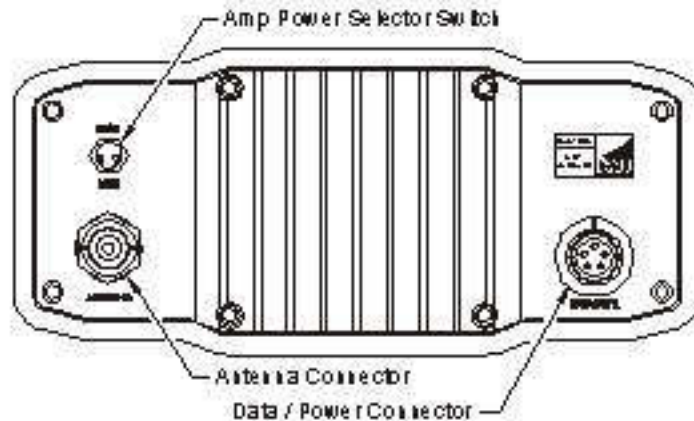

Figure 2 - PDL High Power Base Rear Panel

RF Connector

A BNC jack accepts the BNC male plug coming from the antenna mount.

High/Low RF Power Switch

This toggle switch selects high RF power output in the "up" position and low RF power output in the "down" position. Select high RF power for situations where long range is required. For short range applications, select low RF power to reduce power consumption and minimize interference with co-channel users.

Enclosure

The PDL HPB enclosure is rugged extruded aluminum with integrated heat sink fins. The enclosure is painted with a weather resistant powder coat blue paint. Black bumpers are integrated with front and rear gaskets to provide shock protection and watertight operation. The enclosure is not designed to withstand submersion and must not be allowed to sit in standing water.

 **Warning:** The PDL HPB enclosure and heat sink may become very hot during operation. This is normal depending on the ambient temperature, RF power selection and transmission duty cycle. Turn off the unit and allow it to cool prior to handling.

PDL High Power Base System Setup

Antenna and Antenna Mount

Begin your PDL HPB station set up by screwing the Antenna Mount to the top of the Tripod Antenna Mast. You may want to leave the mount permanently attached to the mast and avoid this step in the future.

PDL/ADL/SDL User's Guide

Next, screw the Antenna on the Antenna Mount. We recommend inspecting the antenna center push-pin contact to ensure that it makes good contact with the antenna mount. A good antenna connection is critical to system performance.

Tripod Antenna Mast

With the Antenna Mount and Antenna connected, extend the legs of the Tripod Antenna Mast and set up the tripod on level ground. Spread the tripod legs sufficiently to provide a stable base.



Caution: Do not extend the antenna mast in conditions of high wind or in situations where the uneven terrain or other soil conditions provide an unstable base. Keep the area surrounding the Tripod Antenna Mast clear and exercise caution to prevent injury or damage to property should the Tripod Antenna Mast fall.

Connecting the PDL HPB

The PDL HPB has a built-in tripod mounting bracket that allows easy mounting to the tripod. Locate the mounting flange at the top portion of one of the Tripod legs, and hook the PDL HPB in place.

Connect the antenna, GPS Data Cable and Battery Power Cable as indicated in Figure 3. You are now ready to turn-on the system.

Configuring the GPS Reference Station

Refer to the GPS receiver model specific addendum that is included with this manual for specific instructions on configuring your GPS reference station for optimal performance with the PDL. Detailed instructions are also available on our web site at www.paccrst.com.

PDL Default Settings

The PDL Base is configured at the factory with settings that have been determined to provide excellent system performance. Use the PDLCONF software provided with the product to view and change configuration settings.



Note: Please refer to the PDLCONF help menu system for detailed information concerning the settings.

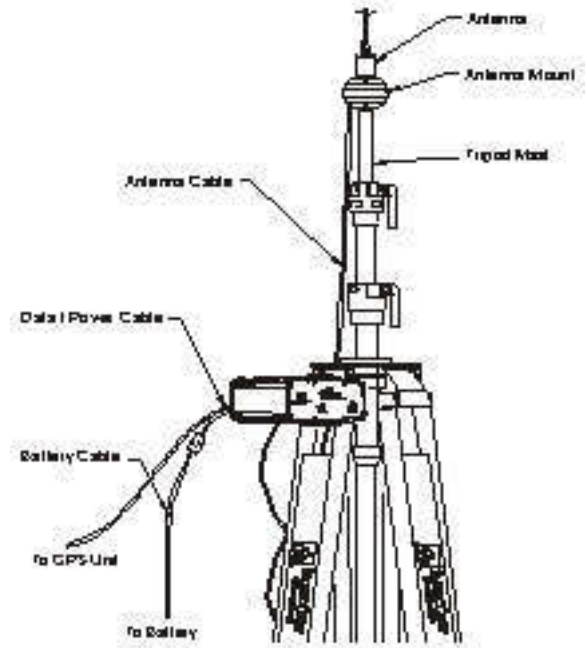

Figure 3 - PDL High Power Base System Setup

The following table shows the default factory settings:

Table 1 - PDL Factory Defaults

<i>Setting</i>	Factory Defaults <i>PDL Base</i>	<i>PDL Rover</i>
Channel mode	AutoBase	AutoRover
GPS Port Data Rate	38.4 k Baud	38.4 k Baud
Parity	None	None
Mode	Transparent with EOT timeout	Transparent with EOT timeout
EOT value	5	5
Retries	3	3
Link rate	9600 kbps (raw data)	9600 kbps (raw data)
Modulation	GMSK	GMSK
FEC	Enabled	Enabled
Data Scrambling	Enabled	Enabled
Digisquelch	Low	High
Break to command	Off	Off
TX ACK timeout	0.10	0.10
CSMA	Enabled	Enabled
Digidelay	0.0	0.0
Repeater	Off	Off
Address (local)	0	0
Address (dest)	255	255

Battery Care

Base station kit shipments to North America include a 33 AHr deep-discharge gel lead acid battery. This battery provides all day operation with ample power for both the PDL and the GPS RTK reference station.

International Shipments

For shipments outside of North America, we include battery bag, power cables with fuse, and hardware for a user supplied battery. Select a deep discharge battery of the type designed for golf cart or wheel chair operation, and that has a capacity of 33 AHr or greater. Batteries designed for automotive use will be damaged by the repetitive discharge/charge cycles and should be avoided.

Charging

The supplied charger provides two-stage charging and should be connected to the battery following every full day of operation to assure good battery life and performance. The first stage quickly charges the battery to capacity and the second stage trickle charges the battery to maintain a full charge.

If the battery is maintained in storage for an extended length of time, it is important to periodically charge the battery as extended time in a discharged state may damage the battery.

This page intentionally left blank.

SETTING UP THE PDL LOW POWER BASE/REPEATER (PDL LPB) Overview of PDL LPB Radio Modem

Front Panel

Buttons

The ON/OFF button is used to turn the PDL LPB modem on and off. Turn the unit on by pressing the ON/OFF button and holding it until the channel display indicator is lit. Turn off the PDL LPB by pressing the ON/OFF button until the display goes blank. There is a one-second turn-off delay in the power button to prevent inadvertent turn off.

The CHANNEL button is used to display and change the channel. Press the CHANNEL button momentarily to display the selected channel. To change the channel, press the CHANNEL button once to light the display, and then again to change the channel. Release the CHANNEL button when the desired channel is indicated.

The PDL LPB can be used as a base, rover or repeater. When used as a base, you have access to AutoBase mode that will aid in the selection of the channel. Use the CHANNEL button to select the "b" setting. With "b" selected, the PDL LPB will be placed in AutoBase mode. This mode selects the channel for transmission automatically.

When used as a rover or repeater, you may wish to use AutoRover mode. Press the CHANNEL button to select the "r" setting. With "r" selected, the PDL LPB will be placed in AutoRover mode. This mode automatically selects the channel being used by the PDL Base. If you are operating in an area with more than one PDL Base station active, you should manually select the channel of operation to assure proper operation.

Display

The seven-segment, numeric display is used to indicate the channel or mode selection. To conserve power, the display is only lit for a short period following the pressing of the CHANNEL or ON/OFF buttons. Channel selections range from Channel 0 to Channel 15. Two digit channel numbers are displayed by alternately flashing a "1" followed by the second digit.

Indicator LEDs

The power LED indicates the power status and also provides a low external voltage supply indicator. When lit, power is turned on. The power LED will blink to indicate if the external voltage supply is approaching the minimum value. If the power LED does not respond to the ON/OFF button, then the level of the external voltage supply should be inspected.

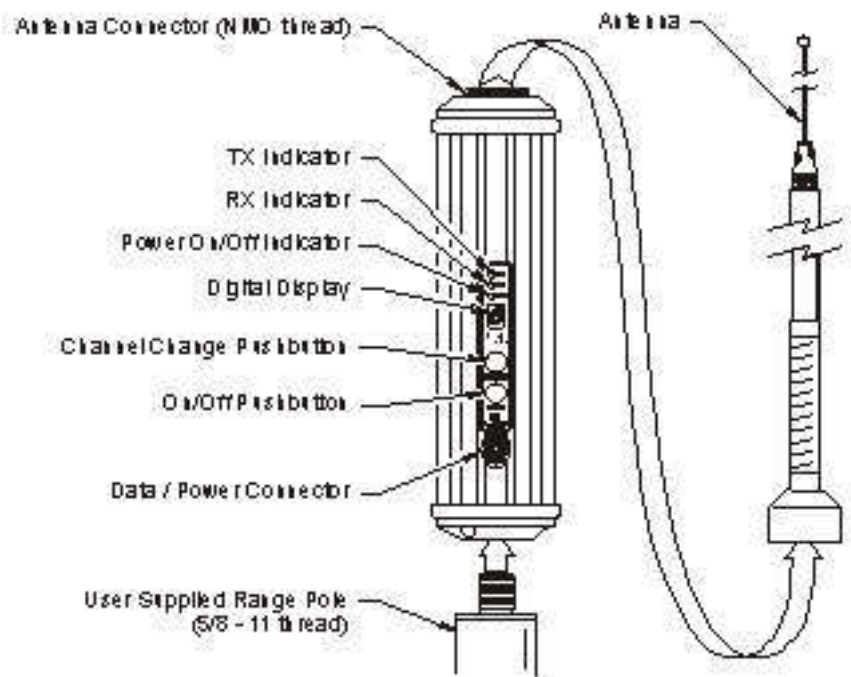

Figure 4 - PDL Low Power Base

PDL/ADL/SDL User's Guide

The RX LED indicates that the PDL LPB is receiving an RF carrier signal from another PDL Base or from another source of interference. During normal operation, the RX LED will flash at a once-per-second rate indicating the transmissions from the PDL Base. If the RX LED is on continuously, then a source of interference may be impacting the ability of the PDL LPB to receive data. Try repositioning the antenna, or you may need to change to another channel at both the base and rover to reduce or eliminate the interference.

The TX LED indicates that the PDL LPB is broadcasting. In most GPS RTK applications, the TX LED will flash approximately one time per second.

Enclosure

The PDL LPB enclosure is a tough, impact resistant blue polycarbonate with machined aluminum end caps. Black bumpers with integrated gaskets provide the first level of shock protection for the internal components. An additional isolation system inside the enclosure reduces vibration impact to the sensitive radio receiver board.

Antenna Mount

The integrated antenna mount provides an industry standard NMO style RF connector that is compatible with a wide range of mobile whip antennas.

Range Pole Mount

The bottom end cap is female threaded with 5/8-11 UNC that is compatible with common range poles. The unit is easily mounted in the place of a stand-alone antenna and eliminates the need for an antenna cable.

PDL Low Power Base Setup

Antenna and Antenna Mount

Screw the Antenna on the antenna mount of the PDL LPB. We recommend inspecting the antenna center push-pin contact to make sure that it makes good contact with the antenna mount. A good antenna connection is critical to system performance.

Range Pole or Tripod Side Bracket Mount

Before connecting any cables, screw the PDL LPB onto the range pole (for tripod-top use) or tripod side mount bracket.

Connecting the PDL LPB

The PDL LPB is connected to the GPS RTK receiver using the supplied cable. After connecting the cable, press the ON/OFF button. Use the CHANNEL button to select the channel of operation, or select "r" for the AutoRover function or select "b" for the AutoBase function. Refer to the How to Use AutoRover and How to Use AutoBase sections of this manual for detailed instructions concerning these features.

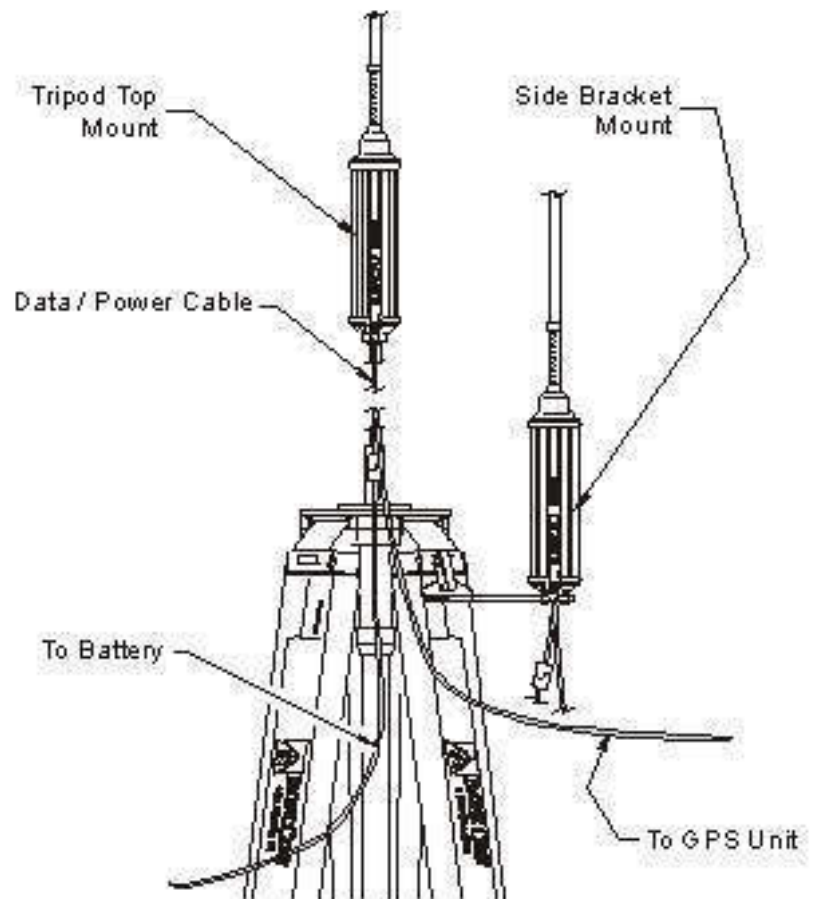

Figure 5 - PDL Low Power Base Setup

PDL/ADL/SDL User's Guide

Configuring the GPS Rover

See the GPS receiver model addendum that is included with this manual for specific instructions on configuring your GPS rover for optimal performance with the PDL. Detailed instructions are also available on our web site at www.paccrst.com.

PDL LPB Default Settings

Refer to Table 1 in Setting Up the PDL HPB for the default factory settings of your PDL LPB.

SETTING UP THE PDL ROVER

Overview of PDL Rover Radio Modem

Front Panel

Buttons

The ON/OFF button is used to turn the PDL Rover modem on and off. When not in use, the PDL Rover should be turned off to conserve battery power.

Turn the unit on by pressing the ON/OFF button and holding it until the channel display indicator is lit. Turn off the PDL Rover by pressing the ON/OFF button until the display goes blank. There is a one-second turn-off delay in the power button to prevent inadvertent turn off.

The CHANNEL button is used to display and change the channel. Press the CHANNEL button momentarily to display the selected channel. To change the channel, press the CHANNEL button once to light the display, and then again to change the channel. Release the CHANNEL button when the desired channel is indicated.

Use the CHANNEL button to select the "r" setting. With "r" selected, the PDL Rover will be placed in AutoRover mode. This mode automatically selects the channel being used by the PDL Base. If you are operating in an area with more than one PDL Base station active, you should manually select the channel of operation to assure proper operation.

Display

The seven-segment, numeric display is used to indicate the channel or mode selection. To conserve power, the display is only lit for a short period following the pressing of the CHANNEL or ON/OFF buttons. Channel selections range from Channel 0 to Channel 15. Two digit channel numbers are displayed by alternately flashing a "1" followed by the second digit.

Indicator LEDs

The power LED indicates the power status and also provides a low battery indicator. When lit, power is turned on. The power LED will blink to indicate that the internal battery requires recharging. If the power LED does not respond to the ON/OFF button, then the internal battery may be fully discharged and must be charged prior to further operation.

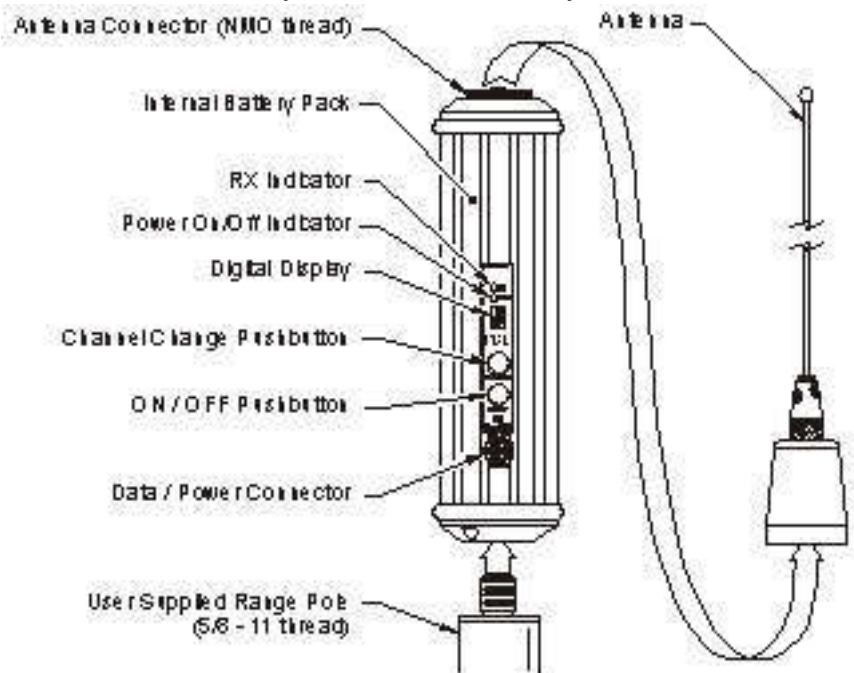

Figure 6 - PDL Rover

PDL/ADL/SDL User's Guide

The RX LED indicates that the PDL Rover is receiving an RF carrier signal from the PDL Base or from another source of interference. During normal operation, the RX LED will flash at a once-per-second rate indicating the transmissions from the PDL Base. If the RX LED is on continuously, then a source of interference may be impacting the ability of the PDL Rover to receive data. Try repositioning the antenna, or you may need to change to another channel at both the base and rover to reduce or eliminate the interference.

Enclosure

The PDL Rover enclosure is a tough, impact resistant blue plastic with machined aluminum end caps. Black bumpers with integrated gaskets provide the first level of bump protection for the internal components. An additional isolation system inside the enclosure reduces shock impact to the sensitive radio receiver board.

Antenna Mount

The integrated antenna mount provides an industry standard NMO style RF connector that is compatible with a wide range of mobile whip antennas. With the internal antenna option, the top end cap NMO style mount is replaced with a 5/8-11 UNC stud, allowing the PDL Rover to be used as part of the pole system with a GPS antenna. See Figure 5.

Range Pole Mount

The bottom end cap is female threaded with 5/8-11 UNC that is compatible with common range poles. The unit is easily mounted in the place of a stand-alone antenna and eliminates the need for an antenna cable.

PDL Rover Setup

Antenna and Antenna Mount

Screw the Antenna on the antenna mount of the PDL Rover. We recommend inspecting the antenna center push-pin contact to make sure that it makes good contact with the antenna mount. A good antenna connection is critical to system performance.

Range Pole Mount

Before connecting any cables, screw the PDL Rover onto the range pole.

Connecting the PDL Rover

The PDL Rover is connected to the GPS RTK receiver using the supplied cable. After connecting the cable, press the ON/OFF button. Use the CHANNEL button to select the channel of operation, or select "r" for the AutoRover function. Refer to the How to Use AutoRover section of this manual for detailed instructions concerning this feature.

Configuring the GPS Rover

See the GPS receiver model addendum that is included with this manual for specific instructions on configuring your GPS rover for optimal performance with the PDL. Detailed instructions are also available on our web site at www.paccrst.com.

PDL Rover Default Settings

Refer to Table 1 in Setting Up the PDL Base for the default factory settings of your PDL Rover.

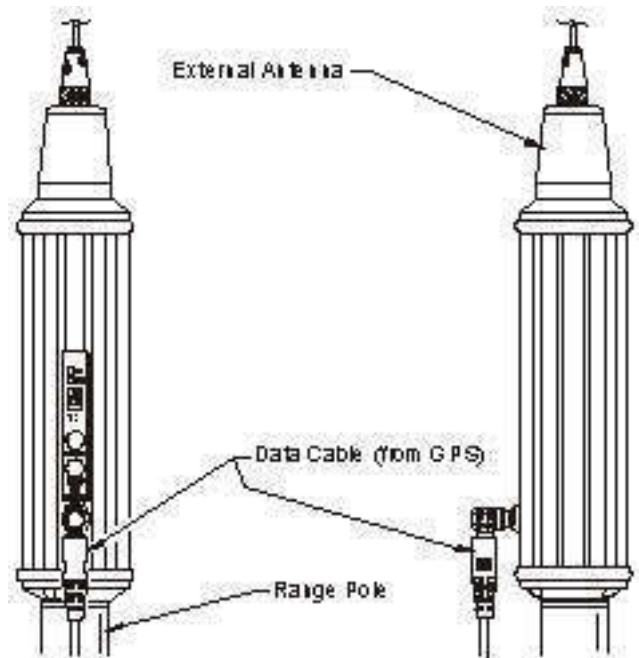



Figure 7 - PDL Rover Setup

Battery Care

The PDL Rover has an internal power supply that allows all-day operation without taking power from the GPS. The light-weight Lithium-Ion single cell battery can be recharged more than 1000 times, providing 3+ years of normal use. We recommend daily charging for best battery life and performance.

 **Warning:** The internal Lithium-Ion battery is NOT USER SERVICEABLE. Do not attempt to open the enclosure or replace the battery. Lithium-Ion batteries can be dangerous if mishandled.

The PDL Rover has a built-in charger that monitors and controls the charging of the internal battery. The internal battery quickly charges in less than 4 hours, and can be charged with the supplied charger, or from an external 12 volt supply. We recommend charging the internal battery at room temperature. Charging is inhibited if the ambient temperature is below 0° C or above 40° C.

 **Warning:** The internal battery must not be subject to operating temperatures below -20° C. Subjecting the battery to conditions below -20° C will produce permanent battery damage, and is not covered by the warranty.

TIPS AND TECHNIQUES FOR BEST PERFORMANCE

Antenna

Antenna placement is critical for good performance. Range and coverage is directly proportional to the height of the transmitting and receiving antennas. Where possible, select a reference station location that takes advantage of terrain to get the transmitting antenna as high as possible.

Always use the telescoping antenna mast, and raise the antenna as high as is practical and safe, given terrain and wind conditions.

Power Supplies

Maintain batteries in a fully charged state. Both the PDL Base and internal PDL Rover batteries will live longer if not allowed to become completely discharged. We recommend routinely connecting both the base and rover PDLs to their chargers on a nightly basis. This will assure optimal performance and long battery life.

How to Use AutoRover™

AutoRover is a feature that allows the PDL Rover to automatically synchronize to the PDL Base. Enable this feature by pressing the CHANNEL button until an "r" is displayed. After selecting "r", you will note that the display will flash each programmed channel for approximately 3 seconds, until a base station broadcast is encountered. The PDL Rover will continue to scan until a broadcast is found.

The next time you turn on your unit, you will see an "r" momentarily, after which the scan process will begin. To manually select a channel for operation, press the CHANNEL button until the desired channel is displayed.

With AutoRover the PDL Rover scans each programmed operating frequency, looking for a signal from the PDL Base. When a signal is found, the PDL Rover selects that channel for operation.

 **Caution:** Multiple PDL Base stations operating in a single area may lead to the PDL Rover selecting the wrong base. In such circumstances, we recommend manually selecting the channel.

How to Use AutoBase™

AutoBase is a feature that allows the PDL Base to automatically select a channel based on a channel selection algorithm. These features can be selectively turned off to allow you to manually select the channel of operation on both the PDL Base and Rover.

PDL/ADL/SDL User's Guide

To enable AutoBase, press the CHANNEL button on the PDL Base until an "b" is displayed. After selecting "b", you will note that the display will flash each programmed channel for approximately 1 minute, during which time the channel is analyzed for background noise and co-channel interference.

After cycling through all channels, the PDL Base will select the channel that appears to provide the clearest channel access. Following channel selection, the data received from the GPS will automatically begin transmitting.

 **Warning:** Depending on the number of channels programmed, channel selection can take from 1 to 16 minutes. We recommend that you set up and turn on your PDL Base station as soon as possible during system setup to prevent delays.

Equipment Care

Routine equipment care will prolong the life and reliability of your PDL family products. Radio communication equipment is susceptible to damage from shock or environmental extremes. Never operate the PDL equipment out of the operating specifications contained in Appendix B.

Error Codes

The PDL performs a variety of power-up and run-time tests to assure optimal operation. Tests include environmental as well as electrical measurements designed to avoid damage to the unit while maintaining adequate operation. In the event of an error condition, a 3-digit error code is flashed on the display. Error codes begin with an "E" followed by two numeric digits indicating the failure mode. Table 2 lists the possible error conditions.

Table 2 - PDL Error Codes

Code Description

E01	External voltage too high
E02	External voltage too low
E03	External voltage too low for transmission
E04	Rover internal battery requires replacement
E05	Rover internal battery charge current too high
E06	Rover internal battery charge current too low
E07	Unit temperature exceeds safe limit for 35 W operation
E08	Unit temperature exceeds safe limit for 2 W operation
E09	Current consumption too high for 35 Watt operation
E10	Current consumption too high for 2 Watt operation
E11	Checksum error
E12	RAM error
E13	EEPROM error
E14	FLASH error
E16	Synthesizer not locked
E99	Unknown error

What to do

E01-E03 Check battery or power supply voltage level, check power cables, recharge or replace battery, check charger.

E07-E10 Check antenna and antenna cables, use 19200 link rate to reduce duty cycle, select low RF power.

E04-E06, E11-E16, E99 Contact customer service.

Cycle power to clear error codes. If codes persist, contact factory.

FCC RULES AND REGULATIONS

Licensing Requirements

It is the responsibility of the PDL Base station owner to comply with applicable rules and regulations concerning the operation of a radio transmitter. In the United States, the FCC regulates the licensing of this equipment.

Application for a license is made by submitting FCC form 600 along with evidence of frequency coordination (if required) and applicable fees. Similar licensing requirements exist worldwide. Penalties for broadcasting without a license can be severe, and may include the confiscation of your radio and GPS equipment.

For more information, contact our customer service department.



Warning: Always obey local licensing requirements and restrictions.

Equipment Compliances

PDL products have been tested and found to comply with Parts 15 and 90 of Title 47 of the Code of Federal Regulations. The PDL products have also been tested and found compliant for type certification and approval in many other countries worldwide.

For more information concerning our worldwide compliances, contact our customer service department.

Being Part of the RF community

Operation of a licensed radio product makes you a member of the RF community. Be aware that virtually all frequencies licensed are provided on a shared basis with other users. Each frequency used in RTK GPS activities has certain restrictions and limitations. For complete information, refer to Part 90, Title 47, of the Code of Federal Regulations.

Most frequencies sharing data transmissions and voice transmissions give priority to voice users. Be mindful of the persistent nature of a GPS RTK data transmission and always limit your RF transmission output power when performing close-in survey situations to avoid interference with co-channel users. We recommend using the low RF power setting for construction site and other line-of-site surveys with baselines less than 2 miles (depending on terrain).

Warning: If you are in conflict with a co-channel user, select another frequency to avoid formal FCC actions. In most cases you are required to vacate a frequency upon complaint by a shared channel voice user.

Most survey operations are itinerant in that the system is moved on a frequent basis. For fixed system installations, you should not use frequencies set aside for itinerant operations, but should coordinate a frequency based on the fixed area operation.

Regulations differ from country to country, so please be aware of the local regulations prior to using the PDL equipment.

Automatic Station Identification

For operation in the United States, the FCC requires that radio transmitters used for GPS RTK applications periodically broadcast a station identifier. The station identifier is the call sign assigned to you on the station license.

The PDL supports the broadcast of station identification in a manner that meets the requirements of the FCC. Upon receipt of equipment, program your FCC callsign into the configuration of your PDL using PDLCONF software. This is only required for transmitters.



Warning: Failure to transmit your station identification is in violation of FCC regulations. Use PDLCONF software to enter your FCC callsign.

Carrier Sense Multiple Access (CSMA)

CSMA is a technology implemented in the PDL Base to meet FCC transmitter requirements. CSMA holds off the radio transmission if the frequency is currently being used by a co-channel user. On occasion, you may note that the radio broadcasts stop for short periods of time. Most often, this is a case of co-channel interference and the PDL Base is holding off broadcasts due to the FCC mandated CSMA.

GPS RTK equipment is designed to function with intermittent gaps in the data. Heavy co-channel use may limit the ability of the PDL Base to transmit the required information. In areas of heavy co-channel usage, try changing channels to a less used frequency.

SERVICE AND SUPPORT

WARRANTY

Two-year Limited Warranty

This warranty gives you specific legal rights. You may also have other rights which vary from state to state or area to area.

Shenzhen Sinosun Inc warrants PDL family products, exclusive of cables and batteries, against defects in materials and workmanship for a period of two years from receipt by the end user. Cables and batteries carry a one year warranty against defects in materials and workmanship.

Exclusions

Should **Shenzhen Sinosun Inc** be unable to repair or replace the product within a reasonable amount of time, a refund of the purchase price may be given upon return of the product.

The warranty on your PDL radio modem shall not apply to defects resulting from:

- Improper or inadequate maintenance by the customer
- Unauthorized modification or misuse
- Operation outside of the environment specifications
- Negligence or misuse

Warranty Limitations

This warranty set forth above is exclusive and no other warranty, whether written or oral, is expressed or implied. **Shenzhen Sinosun Inc** specifically disclaims the implied warranties of merchantability and fitness for a particular purpose.

This page intentionally left blank.

WARRANTY

Two-year Limited Warranty

This warranty gives you specific legal rights. You may also have other rights which vary from state to state or area to area.

Shenzhen Sinosun Inc warrants PDL family products, exclusive of cables and batteries, against defects in materials and workmanship for a period of two years from receipt by the end user. Cables and batteries carry a one year warranty against defects in materials and workmanship.

Exclusions

Should **Shenzhen Sinosun Inc.** be unable to repair or replace the product within a reasonable amount of time, a refund of the purchase price may be given upon return of the product.

The warranty on your PDL radio modem shall not apply to defects resulting from:

- Improper or inadequate maintenance by the customer
- Unauthorized modification or misuse
- Operation outside of the environment specifications
- Negligence or misuse

Warranty Limitations

This warranty set forth above is exclusive and no other warranty, whether written or oral, is expressed or implied. **Shenzhen Sinosun Inc** specifically disclaims the implied warranties of merchantability and fitness for a particular purpose.

This page intentionally left blank.

APPENDIX A - SAFETY INFORMATION

Exposure to Radio Frequency Energy

The PDL radio modem products are designed to comply with the following national and international standards and guidelines regarding exposure of human beings to radio frequency electromagnetic energy:

- FCC Report and Order FCC 96-326 (August, 1996)
- American National Standards Institute (C95.3-1992)
- National Council on Radiation Protection and Measurement (NCRP - 1986)
- International Commission on Non-ionizing Radiation Protection (ICNRP - 1986)
- European Committee for Electrotechnical Standardization (CENELEC)

To assure optimal radio performance and to ensure that exposure to RF energy is within the guidelines in the above standards, the following operating procedures should be observed:

- DO NOT operate a transceiver when someone is within the distance noted below of the antenna
 - 1 m (approx. 40 inches) for PDL HPB 35 Watt
 - 30 cm (approx. 12 inches) for PDL LPB 2 Watt
 - 15 cm (approx. 6 inches) for PDL LPB 1/2 Watt
- DO NOT operate the transceiver unless all RF connectors are secure and any open connectors are properly terminated.
- DO NOT operate the transceiver with a damaged antenna. If a damaged antenna comes in contact with the skin, a minor burn may result.
- DO NOT operate the equipment near electrical blasting caps or in an explosive atmosphere.

APPENDIX B - PIN-OUTS AND CONNECTORS

PDL High Power Base

The PDL Base data receptacle is a LEMO PN HGG.1B.305.CLLP. For a mating plug, we recommend LEMO PN FGG.1B.305.CLAD.72Z. Refer to Table 2 and Figure 6 for pin-outs and orientation.

PDL Low Power Base and Rover

The PDL Rover data receptacle is a LEMO PN HMG.0B.305.CLN. For a mating plug, we recommend LEMO PN FHG.0B.305.CLAD.52Z. Refer to Table 2 and Figure 7 for connector pin assignments.

Table 3 - PDL Base and Rover Pin Assignments

Pin #	Description	Cable Wire Color
1	Power	Red
2	Ground	Black
3	RS-232 RX Data	Yellow
4	RS-232 Signal Ground	White
5	RS-232 TX Data	Green

Antenna

The PDL High Power Base antenna connector is a BNC female. For a mating plug, we recommend Amphenol PN 31-320. Use only high quality 50 impedance cable for the antenna connection.

The PDL Low Power Base and Rover antenna connector is an industry standard NMO. The impedance is 50.

Connector Manufacturer Contacts

Contact LEMO USA by calling 1-707-578-8811

Contact Amphenol by calling 1-203-743-9272

Figure 8 - PDL Data/Power Connectors

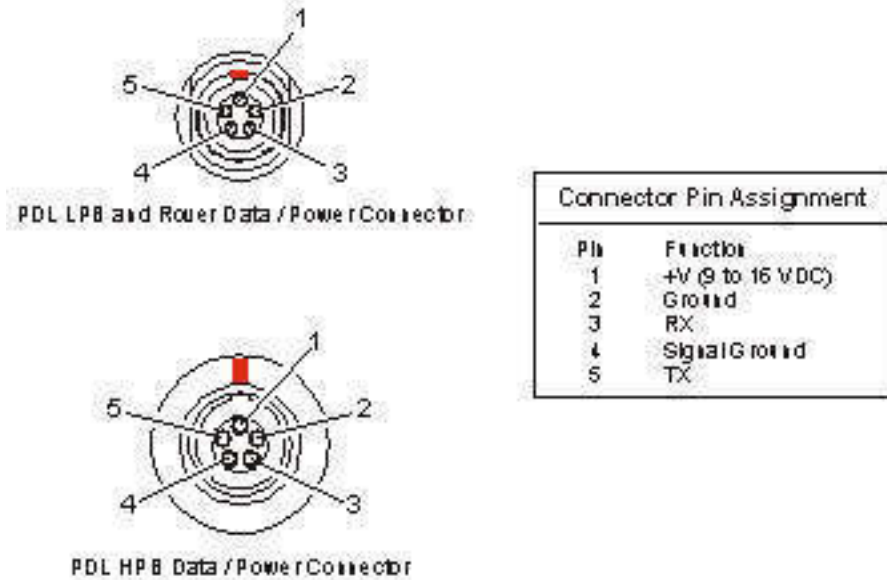

APPENDIX C - TECHNICAL SPECIFICATIONS

General

Serial Port Interface

RS-232 compatible. 1200 to 38400 baud operation with 1 start, 8 data, optional parity, and one stop bit.

Power Supply

9-16 VDC. PDL Rover quiescent/receive power consumption 0.3W. PDL/ADL/SDL High Power Base quiescent/receive power consumption is 1.9W. PDL/ADL/SDL Base in the low/high RF power setting consumes 13W/125W during transmission. The PDL Low Power Base quiescent/receive power consumption is 0.9W. The PDL Low Power Base when transmitting consumes 5W/11W. (PDL Base power consumption measured at 12.5 VDC.)

Radio

Frequency Ranges

Contact factory for available frequency ranges. Synthesized frequency control with approximately 1600 channel capability. Channel spacing 25/12.5 kHz. 2.5 ppm frequency reference.

Transmitter (PDL Base)

Carrier power 2-Watts or 35(45/25)-Watts nominal for PDL(ADL/SDL). Carrier power for the Low Power Base is factory programmable for the 0.5W or 2W. Output impedance 50-ohms. Modulation distortion is less than 5%. Transmitter attack time < 18 ms. Spurious and harmonic FM -55 dBc. FM hum and noise -40 dBm.

Receiver

Sensitivity -116 dBm or better (12dB SINAD). Selectivity for the PDL HPB and Rover is >-60 dB. Selectivity for the PDL LPB is >-70dB. (9600, GMSK, 25 KHz), and >-60 dB (19,200, 4LFSK, 25 KHz). FM hum and noise -40 dB. Conducted spurious -65 dB. Carrier detect attack time 2 ms.

Modem

Transmission Rate

19,200 or 9,600 bits per second (Four-level FSK)
9,600 or 4,800 bits per second (GMSK)

Transmission Protocols

Transparent, packet switched, auto-repeater, fast asynchronous, Trimtalk™.

Forward Error Correction and Detection

With FEC enabled, data is encoded by a block code. The data is interleaved in blocks of 20 words, giving burst error correction capabilities for up to 20 consecutive corrupted bits. 16-bit CRCs are generated and sent with every block of data providing 100% error detection for burst errors shorter than 16 bits, and 99.9984% detection of all other burst errors.

Modulation

Gaussian Minimum Shift Keying (GMSK) with BT of 0.5 (4800, 9600 bps link rate). Four-level FSK (9600, 19200 bps link rate).

APPENDIX C - TECHNICAL SPECIFICATIONS**Environmental***Size*

PDL LPB and Rover - 8.25"L x 2.40"D (21.0cmL x 6.1cmD)

PDL HPB - 6.23"W x 2.77"H x 6.58"L (15.8cmW x 7.0cmH x 16.7cmL)

ADL - 11.9W x 8.6H x 21.3Lcm SDL - 11.5W x 5.2H x 15.1Lcm

Weight

PDL Rover - 0.85 lbs. (0.39 Kg)

PDL HPB - 3.22 lbs. (1.46 Kg)

PDL LPB - 0.65 lbs. (0.30 Kg)

ADL - 1.95Kg SDL - 0.80Kg

Shock and Vibration

Per ANSI/ASAE EP455

Protection

Per IEC 144/855420 I.P. 66 Dust-tight and watertight

Temperature Range

PDL Rover Operating - -40 to 140 F (-40 to 60 C)

PDL Rover Storage - -40 to 185 F (-20 to 85 C)

PDL/ADL/SDL HPB and LPB Operating - -22 to 140 F (-30 to 60 C)

PDL/ADL/SDL HPB and LPB Storage - -67 to 185 F (-55 to 85 C)